

# use & care guide

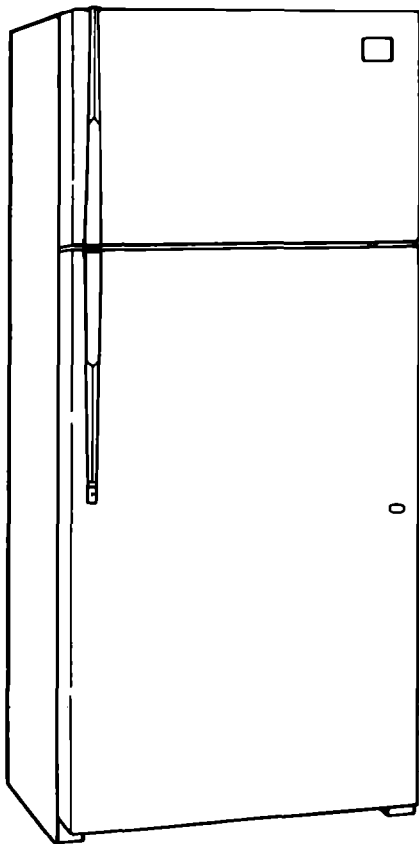

## **NO-FROST REFRIGERATOR- FREEZER**

**Model ET16JM  
&  
Model ET16JK**

ers, Freezers, Refrigerator-Freezers, Ice Makers, Dishwashers, Built-In Ovens and Surface Units, Ranges, Microwave Ovens, Trash Compactors, Room Air Conditioners, Dehumidi

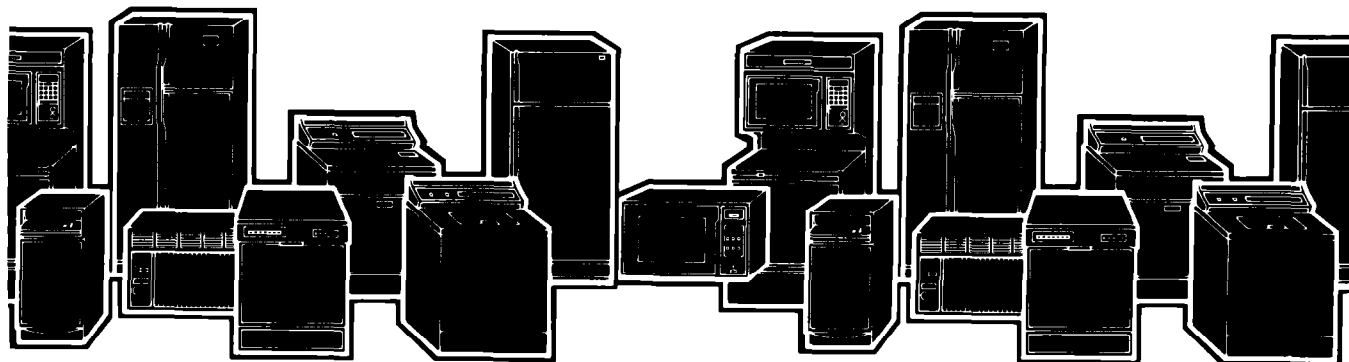

# Please read this Use and Care Guide before you do anything else...

This booklet tells you how to start your refrigerator, clean it, move shelves and adjust controls. It even tells you what new sounds to expect from your refrigerator.

Treat your new refrigerator with care. Use it only to do what home refrigerators are designed to do.

## Parts and features

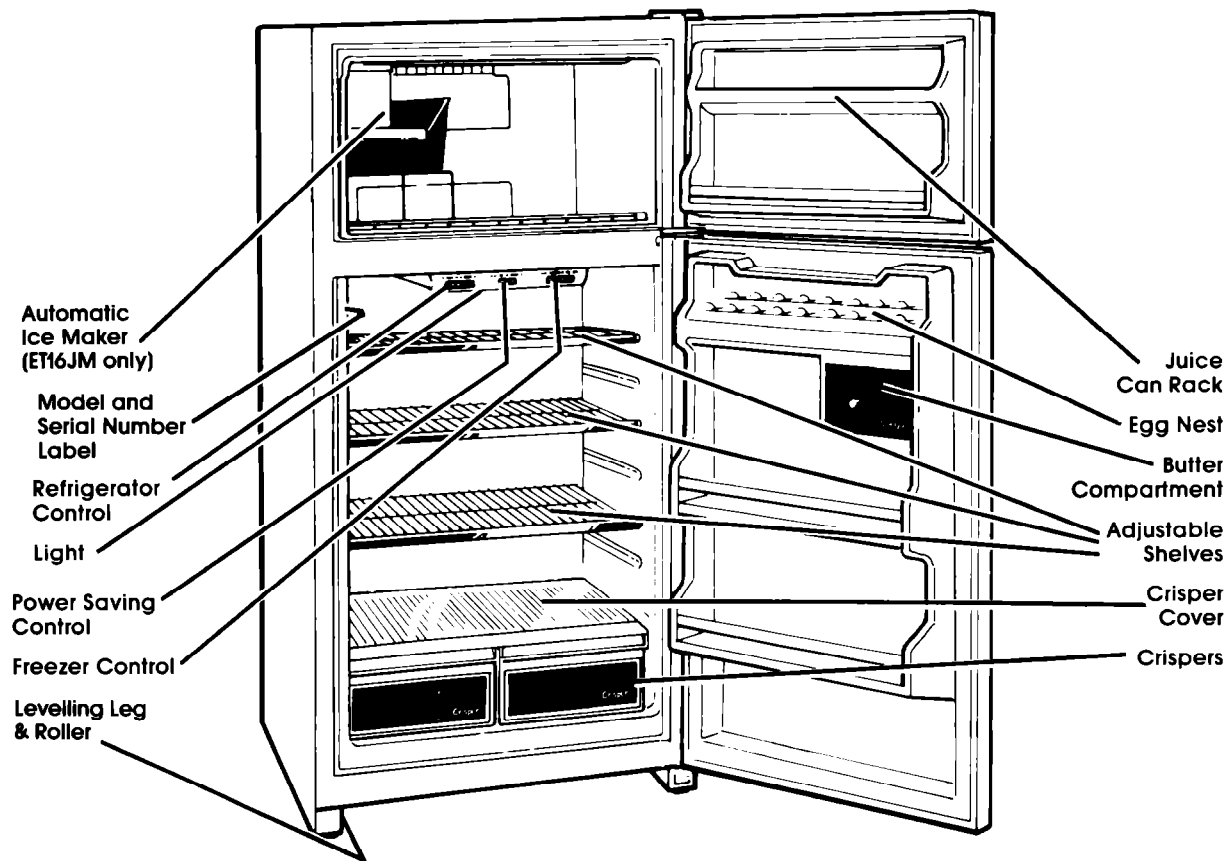

### Copy your Model and Serial Numbers here...

When you need service or call with a question, have this information ready:

1. **Complete** Model and Serial Numbers (from the label located as shown).
2. Purchase date from sales slip.

Copy this information in these spaces. Keep this book, your warranty and sales slip together in a handy place.

\_\_\_\_\_

**Model Number**

\_\_\_\_\_

**Serial Number**

\_\_\_\_\_

**Purchase Date**

\_\_\_\_\_

**Service Company and Telephone Number**

## Contents

	Page		Page
<b>SAFETY FIRST</b> .....	3	Ice Cube Trays .....	7
<b>BEFORE YOU PLUG IT IN</b> .....	3	Sounds You May Hear .....	7
Install Properly .....	4	Energy Saving Tips .....	7
Level Refrigerator-Freezer .....	4	<b>CLEANING YOUR REFRIGERATOR</b> .....	7
Remove Sales Label .....	4	Cleaning Chart .....	8
Clean It .....	4	<b>FOOD STORAGE GUIDE</b> .....	9
Plug It In .....	4	Storing Fresh Food .....	9
<b>USING YOUR REFRIGERATOR</b> .....	5	Storing Frozen Food .....	10
Setting the Controls .....	5	<b>VACATION AND MOVING CARE</b> .....	10
Power Saving Control .....	5	<b>IF YOU NEED SERVICE OR ASSISTANCE</b> .....	11
Changing the Control Settings .....	5	1. Before Calling for Assistance .....	11
Adjusting the Shelves .....	6	2. If You Need Assistance .....	11
Removing the Crispers and Cover .....	6	3. If You Need Service .....	11
Changing the Light Bulb .....	6	4. If You Have a Problem .....	11
Automatic Ice Maker .....	6		

©1986 Whirlpool Corporation

## Safety first

Child entrapment, and suffocation, are not things of the past. Junked or abandoned refrigerators are still dangerous... even if they will "just sit in the garage for a few days."

If you are getting rid of your old refrigerator, do it safely. Please read the enclosed safety booklet from the Association of Home Appliance Manufacturers. Help prevent accidents.

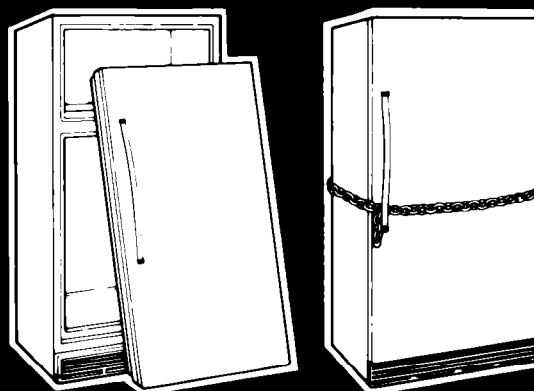

## Before you plug it in

### IMPORTANT

Before using your refrigerator, you are personally responsible for making sure that it...

- is installed and leveled on a floor that will hold the weight, and in an area suitable for its size and use.
- is connected only to the right kind of outlet, with the right electrical supply and grounding. (Refer to your "Electrical Requirements and Grounding Instructions.")
- is used only for jobs expected of home refrigerators.
- is not near an oven, radiator or other heat source.
- is properly maintained.
- is out of the weather.
- is used in an area where the room temperature will not fall below 55° F (13° C).
- is not used by those who may not understand how it should be used.
- is not loaded with food before it has time to get properly cold.

## Install properly...

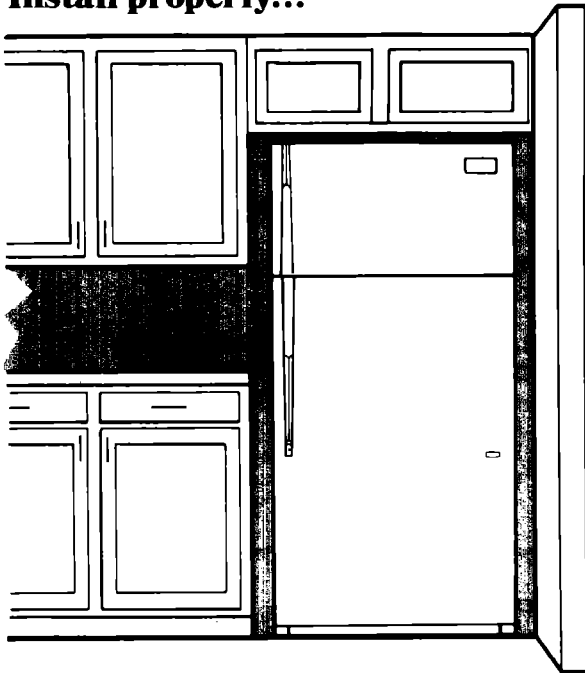

1. Allow 3 inches (7.5 cm) between overhead cabinets and the refrigerator top.
2. Allow at least an inch (2.5 cm) between the refrigerator condenser and the wall.
3. Allow ½ inch (1.25 cm) on each side of the refrigerator for ease of installation.
4. If the refrigerator is to be against a wall, you might want to leave enough space so the door can be opened wider.

## Level refrigerator-freezer...

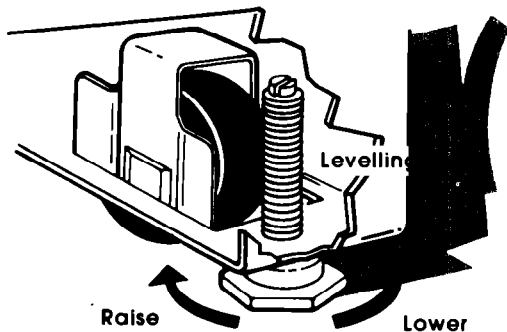

This refrigerator has 2 threaded levelling legs that are shipped in a separate package.

1. Screw these legs all the way into bolt holes in the bottom front corners of the refrigerator.
2. Slide the refrigerator into place.
3. Adjust front legs to level the refrigerator.
  - To raise corners, turn legs in direction shown.
  - To lower corners, turn legs in direction shown.
4. Check with level.

## Remove sales labels...

Remove the Consumer Buy Guide label, tape and any **inside** labels before using the refrigerator.

### To remove any remaining glue:

1. Rub briskly with thumb to make a ball then remove.
- OR**
2. Soak area with dishwashing detergent solution (1 teaspoon detergent in 1 quart warm water) before removing glue as described in step 1.

**DO NOT USE rubbing alcohol or flammable or toxic solvents, such as acetone, gasoline, carbon tetrachloride, etc. These can damage the material.**

**NOTE: DO NOT REMOVE ANY PERMANENT INSTRUCTION LABELS INSIDE YOUR REFRIGERATOR.**

**Do not remove the Tech Sheet fastened under the refrigerator at the front.**

## Clean it...

Clean your refrigerator before using it. See cleaning instructions on pages 7 and 8.



## Plug it in...

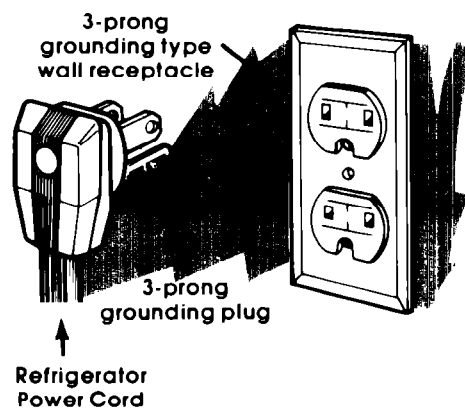

### RECOMMENDED GROUNDING METHOD

A 115 Volt, 60 Hz., AC only 15 or 20 ampere fused and properly grounded electrical supply is required. It is recommended that a separate circuit serving only this appliance be provided.

**Do not use an extension cord. Use a receptacle which cannot be turned off with a switch or pull chain.** See individual electrical requirements and grounding instruction sheet in your literature package.

# Using your refrigerator

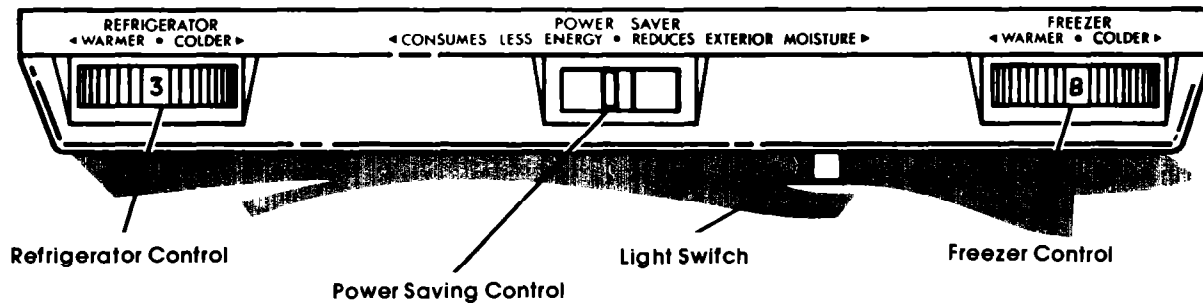

## Setting the controls...

Controls for the refrigerator and freezer are in the refrigerator. When the refrigerator is plugged in for the first time...

1. Set the REFRIGERATOR CONTROL to 3.



2. Set the FREEZER CONTROL to B.



**Give the refrigerator time to cool down completely before adding food.** (This may take several hours.)

**These settings should be about right for normal household refrigerator usage.**

The controls will be set about right when milk or juice is as cold as you like and when ice cream is firm.

## Power Saving Control...

The **Power Saving Control** on the Control Console operates electric heaters around the door openings. These heaters help keep moisture from forming on the outside of the refrigerator.

**POWER SAVER**  
◀ CONSUMES LESS ENERGY • REDUCES EXTERIOR MOISTURE ▶



1. Use the "CONSUMES LESS ENERGY" setting when humidity is low.
2. Use the "REDUCES EXTERIOR MOISTURE" setting only if moisture forms on the outside of the refrigerator.

## Changing the control settings...

If you need to adjust temperatures in refrigerator or freezer, use the settings listed in the chart below.

- Adjust the Refrigerator Control first.
- Wait at least 24 hours between adjustments.
- Then adjust the Freezer Control, if needed.



### QUESTIONS?

...call your **COOL-LINE®** service assistance telephone number (page 11).

#### CONDITION:

If Refrigerator Section is **TOO WARM**

If Freezer Section is **TOO WARM**

If Refrigerator Section is **TOO COLD**

If ICE isn't **MADE FAST ENOUGH**

If **BOTH SECTIONS** are **TOO WARM**

#### REASONS:

Door opened often  
Large amount of food added  
Room temperature too warm

Door opened often  
Large amount of food added  
Very cold room temperature (can't cycle often enough)

Controls not set correctly for your conditions

Heavy ice usage  
Very cold room temperature (can't cycle often enough)

Door opened often  
Large amount of food added  
Very warm or very cold room temperatures

#### RECOMMENDED CONTROL SETTINGS:

Refrigerator 4  
Freezer C

Refrigerator 3  
Freezer A

Refrigerator 2  
Freezer B

Refrigerator 3  
Freezer A

Refrigerator 4  
Freezer B

## Adjusting the shelves...

1. First, remove food from shelf.
2. Slide shelf straight out to stop.
3. Lift front.
4. Slide the rest of the way out.

### Replacing Shelf:

1. Fit back of shelf on top of guides with wire stops on the bottom of guides.
2. Lift front, slide shelf in until it clears guide stops.

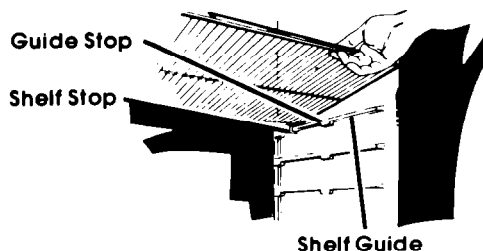

## Removing crispers and crisper cover...

### Removing the Crispers:

1. Slide crisper straight out to stop, lift front, then slide the rest of the way out.
2. Replace in the reverse order.

### Removing Cover:

1. Lift front and remove the cover support.
2. Lift out cover by pulling up and out.

### Replacing Cover:

1. Fit back of cover into notch supports on walls of refrigerator, then lower front into place.
2. Replace cover support with the long tab towards the front. **Note:** If support needs adjustment, turn base right to raise, or left to lower.

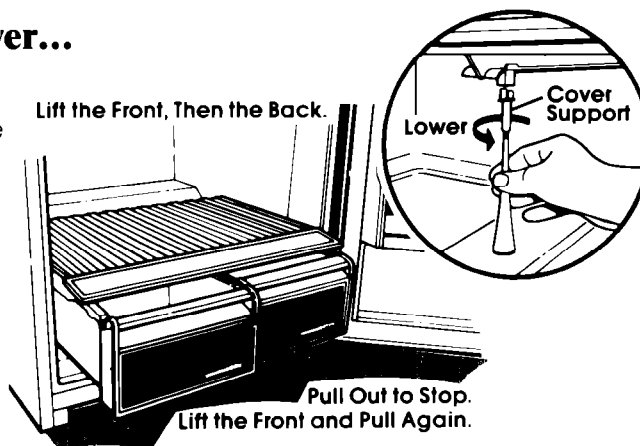

## Changing the light bulb...

**WARNING:** Before removing the light bulb, either unplug the refrigerator or disconnect the electricity leading to the refrigerator at the main power supply. Shock and injury can occur if electricity remains connected.

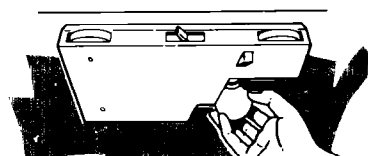

### Unplug the refrigerator first.

1. Reach behind control console to find bulb.
2. Remove bulb.
3. Replace with a 40-watt appliance bulb.

## Automatic ice maker...

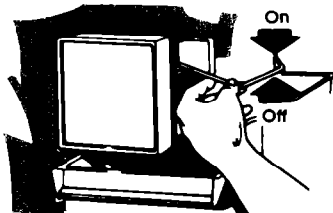

Raise Signal Arm to Stop Ice Maker.

Lower Signal Arm to Start It.

If you have Model ET16JM and have the automatic ice maker accessory, or if you have Model ET16JK and plan to add one later (Part No. ECKMF-83), there are a few things you will want to know:

- The ON/OFF lever is a wire signal arm.
  - Down...for making ice automatically;
  - Up...to shut off the ice maker.
- Shake the bin occasionally to keep cubes separated, and to obtain increased storage capacity.
- It is normal for ice crescents to be attached by a corner. They will break apart easily.
- You will hear water running when ice maker is working. You'll hear ice fall into the bin. Don't let these sounds bother you.
- The ice maker will not operate until the freezer is cold enough to make ice. This can take overnight.

• Because of new plumbing connections, the first ice may be discolored or off-flavored. Discard the first few batches of ice.

• If ice is not being made fast enough and more ice is needed, turn the Refrigerator Control toward a higher number. Wait a day and, if necessary, turn the Freezer Control toward A.

• If you remove the ice bin, raise the signal arm to shut off the ice maker. When you return the bin, push it all the way in and lower the arm to the ON position.

• If cubes are stored too long, they may develop an off-flavor...like stale water. Throw them away. They will be replaced. Cubes in the ice bin can also become smaller by evaporation.

• Good water quality is important for good ice quality. It is not recommended that the ice maker be connected to a softened water supply. Water softener chemicals such as salt from a malfunctioning softener can damage the ice maker mold and lead to poor quality ice. If a softened water supply cannot be avoided, then it is important that the water softener be well maintained and operating properly.

## Ice cube trays... (Model ET16JK Only)

If cubes are not used, they may shrink. The moving cold air starts a slow evaporation. The longer cubes are stored, the smaller they get.

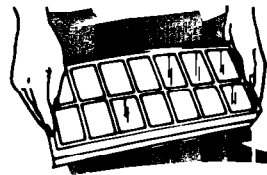

### To remove ice:

1. Hold tray at both ends.
2. Slightly twist.

## Sounds you may hear...

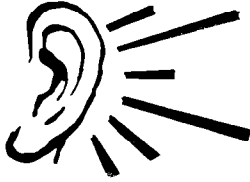

Your new refrigerator may make sounds that your old one didn't. Because the sounds are new to you, you might be concerned about them. Don't be. Most of the new sounds are normal. Hard surfaces like the floor, walls and cabinets can make the sounds seem louder.

The following chart describes the kinds of sounds that might be new to you, and what may be making them.

### Possible Sounds:

- Slight Hum, Soft Hiss:

### Probable Causes:

You may hear the refrigerator's fan motor and moving air.

- Clicking or Snapping Sounds:

The defrost timer makes a definite click when the refrigerator stops running. It also makes a sound when the refrigerator starts.

- Water Sounds:

When the refrigerator stops running, you may hear gurgling in the tubing for a few minutes after it stops. You may also hear defrost water running into the defrost water pan.

- Ice Maker Sounds:

- trickling water
- thud (clatter of ice)

When the ice maker is running, you may hear gurgling (from the water valve), trickling water and the clatter of ice dumped into the bin.

- Running Sounds:

Your refrigerator has a high-efficiency compressor and motor. It will run longer than older designs. It may even seem to run most of the time.

## Energy saving tips...

You can help your refrigerator use less electricity.

- Check door gaskets for a tight seal. Level the cabinet to be sure of a good seal.
- Clean the condenser coil regularly.
- Open the door as few times as possible. Think about what you need before you open the door. Get everything out at one time. Keep foods organized so you won't have to search for what you want. Close door as soon as food is removed.
- Go ahead and fill up the refrigerator, but don't overcrowd it so air movement is blocked.

- It is a waste of electricity to set the refrigerator and freezer to temperatures colder than they need to be. If ice cream is firm in the freezer and drinks are as cold as your family likes them, that's cold enough.
- Keep the Power Saving Control on CONSUMES LESS ENERGY unless moisture forms on refrigerator exterior.
- Make sure your refrigerator is not next to a heat source such as a range, water heater, furnace, radiator, or in direct sunlight.

## Cleaning your refrigerator...

Both the refrigerator and freezer sections defrost automatically. But both should be cleaned about once a month to help prevent odors from building up. Of course, spills should be wiped up right away.

To clean your refrigerator, turn the Refrigerator Control to OFF, unplug it, take out all removable parts, and clean it according to the following directions.

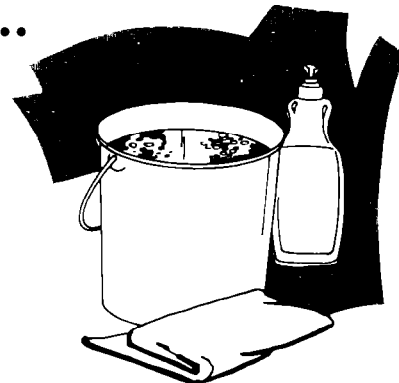

## Cleaning chart...

Part	What to use	How to clean
Removable parts (shelves, crispers, etc.)	Sponge or cloth; mild detergent and warm water.	<ul style="list-style-type: none"> <li>• Wash removable parts with warm water and a mild detergent.</li> <li>• Rinse and dry.</li> </ul>
Outside	Sponge, cloth or paper towel; mild detergent; appliance wax (or good auto paste wax).	<ul style="list-style-type: none"> <li>• Wash with warm water and a mild detergent. <b>Do not use abrasive or harsh cleansers.</b></li> <li>• Rinse and dry.</li> <li>• Wax painted metal surfaces at least twice a year with appliance wax or a good auto paste wax. Apply wax with a clean, soft cloth. <b>Do not use wax on plastic parts.</b></li> </ul>
<b>Waxing painted metal surfaces provides rust protection.</b>		
Inside walls (Freezer should be allowed to warm up so cloth won't stick.)	Sponge, soft cloth or paper towel, baking soda, warm water, mild detergent.	<ul style="list-style-type: none"> <li>• Wash with warm water and – mild detergent or – baking soda (2 tablespoons [26 g] to 1 quart [95 l] warm water.</li> <li>• Rinse and dry.</li> </ul>
Door liners and gaskets	Sponge, soft cloth or paper towel; mild detergent, warm water.	<ul style="list-style-type: none"> <li>• Wash with mild detergent and warm water.</li> <li>• Rinse and dry.</li> </ul>
<b>DO NOT USE Cleaning waxes, concentrated detergents, bleaches or cleansers containing petroleum on plastic parts.</b>		
Dark panels	Mild detergent and warm water; soft, clean sponge and soft, clean cloth.	<ul style="list-style-type: none"> <li>• Wash with a soft grit-free cloth or sponge.</li> <li>• Rinse and dry with a damp grit-free cloth or chamois.</li> </ul>
<b>DO NOT USE paper towels, window sprays, scouring cleansers, or flammable or toxic solvents like acetone, gasoline, carbon tetrachloride, etc. These can scratch or damage the material.</b>		
Defrost pan (behind refrigerator and on top of the motor).	Sponge or cloth; mild detergent and warm water.	<ul style="list-style-type: none"> <li>• Roll refrigerator out only as far as water supply line allows.</li> <li>• Wash defrost pan with warm water and mild detergent. <b>Do not remove defrost pan to clean.</b></li> <li>• Rinse and dry.</li> <li>• Roll refrigerator back.</li> </ul>
Condenser coils	Vacuum cleaner; using the brush attachment.	<ul style="list-style-type: none"> <li>• Clean dust and lint from the condenser coils behind the refrigerator at least every other month.</li> </ul>
Floor under refrigerator	Usual floor cleaners.	<ul style="list-style-type: none"> <li>• Roll refrigerator out only as far as water supply line allows.</li> <li>• Wash floor.</li> <li>• Roll refrigerator back.</li> <li>• Check to see if the refrigerator is level.</li> </ul>



# Food storage guide

## STORING FRESH FOOD



There is a right way to package and store refrigerated or frozen foods. To keep foods fresher, longer, take the time to study these recommended steps.

**Leafy Vegetables**...Remove store wrapping and trim or tear off bruised and discolored areas. Wash in cold water and drain. Place in plastic bag or plastic container and store in crisper. Cold, moist air helps keep leafy vegetables fresh and crisp.

**Vegetables with Skins** (carrots, peppers)...Store in crisper, plastic bags or plastic container.

**Fruits** ...Wash, let dry and store in refrigerator in plastic bags or crisper. Do not wash or hull berries until they are ready to use. Sort and keep berries in their store container in a crisper, or store in a loosely closed paper bag on a refrigerator shelf.



**Meat\*** . . . Meat is perishable and expensive . . . you won't want to waste an ounce of it through careless handling. The following list and chart give you packaging hints and time limits.

**Fresh, Prepackaged Meat.** Store fresh meat in the store wrapping. Vacuum packaged meat can be frozen for as long as one month if the seal is not broken. If you want to keep it frozen longer, you should wrap it with special freezer wrapping material.

**Fresh Meat, Not Prepackaged.** Remove the market wrapping paper and re-wrap in aluminum foil for storing it unfrozen.

**Cooked Meat.** Wrap or cover cooked meat with plastic wrap or aluminum foil. Store immediately.

**Cured or Smoked Meat and Cold Cuts.** Ham, bacon, sausage, cold cuts, etc., keep best in original wrappings. Once opened, tightly re-wrap in plastic wrap or aluminum foil.

**Canned Ham.** Store in refrigerator unless the label says it's okay to store on the shelf. Do not freeze.

**Fresh Poultry**...Wrap in plastic wrap. The plastic wrap on poultry, as purchased, may be used for storage.

### STORAGE CHART FOR FRESH AND CURED MEAT\*

Type	Approximate Time (days)
Variety Meats	1 to 2
Chicken	1 to 2
Ground Beef	1 to 2
Steaks and Roasts	3 to 5
Cured Meats	7 to 10
Bacon	5 to 7
Cold Cuts	3 to 5

\*If meat is to be stored longer than the times given, follow the directions for freezing.

**NOTE:** Fresh fish and shellfish should be used the same day as purchased.

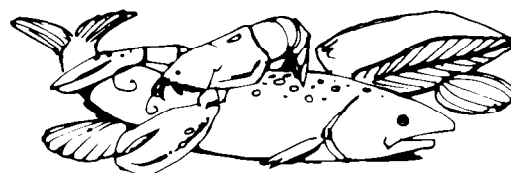

**Eggs** . . . Store without washing in the original carton or use the egg nest in the door of your refrigerator.

**Milk**...Wipe milk cartons. For best storage, place milk on interior shelf.

**Beverages**...Wipe bottles and cans. Store on a door shelf or inside the refrigerator.

**Butter**...Keep open butter in a covered dish or on the Butter Dish in the Butter Compartment. When storing an extra supply, wrap in freezer packaging and freeze.

**Cheese** . . . Store in the original wrapping until you are ready to use it. Once opened, re-wrap tightly in plastic wrap or aluminum foil.

**Condiments** . . . Store small jars and bottles (cat-sup, mustard, jelly, olives) on the door shelves where they are in easy reach.

**Leftovers**...Cover leftovers with plastic wrap or aluminum foil to keep food from drying out and transferring food odors. Plastic containers with tight lids are fine, too.

## STORING FROZEN FOOD

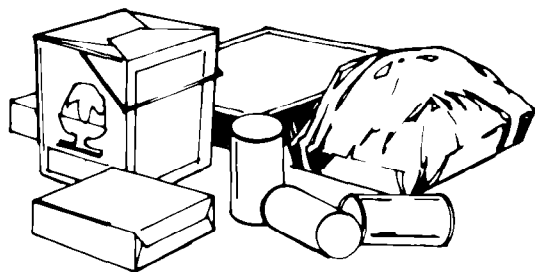

The freezer section is designed for storage of commercially frozen foods and for freezing foods at home.

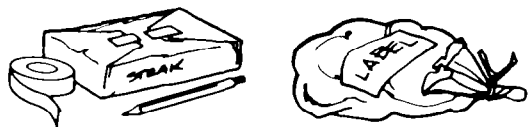

**Packaging** – The secret of successful freezing is in the packaging. The wrap you use must be air, moisture and vapor proof. The way you close and seal the package must not allow air, moisture or vapors in or out.

Rigid polyethylene (plastic) containers with tight-fitting lids, straight-sided canning freezing jars, heavy-duty aluminum foil, plastic-coated paper and non-permeable plastic wraps (such as saran) are recommended. Note: Heat-sealed boiling bags are easy to use and can be used by themselves or as carton liners.

**IMPORTANT: Do not expect your freezer to quick-freeze any large quantity of food. Leave enough space for air to circulate around packages. Be careful to leave enough room at the front so the door can close tightly.**

**Ice Cream**...Store in the freezer. Once the package is opened, place a piece of aluminum foil or plastic wrap smoothly against the ice cream surface. This will prevent ice crystals from forming.

**Packaged Frozen Food** ... Store on freezer door shelf or in the freezer. If you plan to store it for a long time, re-wrap it with aluminum foil or plastic wrap.

**Frozen Meats\*** ... The following hints will help keep the quality in your frozen meats:

1. Freeze meat while fresh and in top condition.
2. Use only recommended wrapping materials.
3. Prepare the meat for freezing before wrapping it. Trim off excess fat and remove bones when practical. Meat should not be salted because salt shortens freezer life.
4. Wrap tightly, pressing out as much air as possible.
5. Label and date it.
6. Refreezing thawed meat is not recommended.

**Frozen Soups, Juices** ... Store on freezer door shelf or in the freezer.

### STORAGE CHART FOR FROZEN FOOD

Storage times given in this chart are only a guide. For best use of freezer space, keep frozen foods for short times. Use, then replace as needed.

<b>Bread</b> .....	<b>2 months</b>
<b>Cooked Dishes</b> .....	<b>2-3 months</b>
<b>Fish and Seafoods</b>	
<b>Fresh</b> .....	<b>6 months</b>
<b>Commercially Frozen</b> .....	<b>1-3 months</b>
<b>Fruits</b> .....	<b>6 months</b>
<b>Ice Cream</b> .....	<b>1 month</b>
<b>Concentrated Juice</b> .....	<b>4-6 months</b>
<b>Meats</b>	
<b>Bacon</b> .....	<b>Less than 1 month</b>
<b>Pork roasts, chops</b> .....	<b>3-4 months</b>
<b>Sausage</b> .....	<b>1-2 months</b>
<b>Beef, veal, lamb roasts</b> .....	<b>6 months</b>
<b>Ground meat</b> .....	<b>1-2 months</b>
<b>Poultry</b> .....	<b>3-4 months</b>
<b>Vegetables</b> .....	<b>6 months</b>

\*Courtesy of National Livestock and Meat Board and U.S.D.A.

## Vacation and moving care **WARNING: Tape blocks out of a child's reach...do not allow children near the refrigerator when the doors are blocked open. They may become injured or trapped.**

### Short vacations...

No need to shut off the refrigerator if you will be away for less than four weeks. Use up the perishables; freeze other items. Turn off your ice maker; shut off the water supply; empty the ice bin and make sure all ice cubes are dispensed out of the mechanism.

### Long vacations. . .

Remove all the food if you are going for a month or more. At least a day ahead, turn off the water supply to the ice maker. When the last load of ice drops, turn off the ice maker.

Unplug the refrigerator and clean it...rinse well and dry. Tape rubber or wood blocks to both doors ...keeping them open far enough for air to get in. This will keep odor and mold from building up.

To restart refrigerator, see "Using Your Refrigerator."

### Moving...

Shut off the ice maker water supply a day ahead of time. Disconnect the water line. After the last supply of ice drops, turn off the ice maker.

Remove all food. Pack frozen foods in dry ice. Unplug the refrigerator and clean it thoroughly.

Remove everything that comes out. Wrap all parts well and tape them together so they don't shift and rattle.

Screw in the levelling legs; tape the doors shut; tape the electric cord to the cabinet. When you get to your new home, put everything back; reconnect the water supply and refer to "Install Properly..." page.

# If you need service or assistance, we suggest you follow these four steps:

## 1. Before calling for assistance...

Performance problems often result from little things you can find and fix yourself without tools of any kind.

### If your refrigerator will not operate:

- Is the power supply cord plugged into a live circuit with the proper voltage? (See page 4.)
- Have you checked your home's main fuses or circuit breaker box?
- Is the Refrigerator Control turned ON?

### If there is a rattling or jingling noise, or other unfamiliar sounds:

- Is something on top or behind the refrigerator making noise when the refrigerator is running?
- New features on your new refrigerator make new sounds. You may be hearing air flowing from the fans, timer clicks for the defrosting cycle; defrost water draining into the defrost pan.

### If your ice maker will not operate:

- Has the freezer had enough time to get cold? With a new refrigerator, this might take overnight.
- Is the signal arm ON...in the down position?
- Is the water valve turned on? Is water getting to the ice maker?

### If there is water in the defrost pan:

- In hot, muggy weather, this is normal. The pan can even be half full. Make sure the refrigerator is level so the pan doesn't overflow.

### If the light does not work:

- Have you checked your home's main fuses or circuit breaker box?
- Is the power supply cord plugged into a live circuit with the proper voltage? (See page 4.)

### If a bulb is burned out:

- See instructions for changing light bulbs on page 6. Use appliance bulbs only.

### If the motor seems to run too much:

- Is the condenser, behind the refrigerator, free of dust and lint?
- On hot days, or if the room is warm, the motor naturally runs longer.
- If the door has been opened a lot, the motor will run longer to cool down the interior.

**Remember:** Motor running time depends on different things: number of door openings, amount of food stored, temperature of the room, setting of the controls.

And, your new refrigerator may be larger than your old one so it has more space to be cooled. It also has a regular freezer instead of a frozen food compartment. All this means better refrigeration and may require more running time than your old one.

## 2. If you need assistance\*...

Call Whirlpool COOL-LINE® service assistance telephone number. Dial free from:

**Continental U.S.** ..... (800) 253-1301  
**Michigan** ..... (800) 632-2243  
**Alaska & Hawaii** ..... (800) 253-1121

and talk with one of our trained Consultants. The Consultant can instruct you in how to obtain satisfactory

operation from your appliance or, if service is necessary, recommend a qualified service company in your area.

## 3. If you need service\*...



Whirlpool has a nationwide network of franchised TECH-CARE Service Companies. TECH-CARE service technicians are trained to fulfill the product warranty and provide after-warranty service, anywhere in the United States. To locate TECH-

CARE service in your area, call our COOL-LINE service assistance telephone number (see Step 2) or look in your telephone directory Yellow Pages under:

<p><b>APPLIANCES - HOUSEHOLD - MAJOR - SERVICE &amp; REPAIR</b></p> <p>WHIRLPOOL APPLIANCES FRANCHISED TECH-CARE SERVICE</p> <p><i>SERVICE COMPANIES</i> XYZ SERVICE CO 123 Maple ..... 999-9999</p>	<p>OR</p>	<p><b>ELECTRICAL APPLIANCES - MAJOR - REPAIRING &amp; PARTS</b></p> <p>WHIRLPOOL APPLIANCES FRANCHISED TECH-CARE SERVICE</p> <p><i>SERVICE COMPANIES</i> XYZ SERVICE CO 123 Maple ..... 999-9999</p>
<p>OR</p>		
<p><b>WASHING MACHINES, DRYERS &amp; IRONERS - SERVICING</b></p>		
<p>WHIRLPOOL APPLIANCES FRANCHISED TECH-CARE SERVICE</p>		
<p><i>SERVICE COMPANIES</i> XYZ SERVICE CO 123 Maple ..... 999-9999</p>		

## 4. If you have a problem\*...

Call our COOL-LINE service assistance telephone number (see Step 2) and talk with one of our Consultants, or if you prefer, write to:

Mr. Robert Stanley  
 Division Vice President  
 Whirlpool Corporation  
 2000 US-33, North  
 Benton Harbor, MI 49022

\*If you must call or write, please provide: model number, serial number, date of purchase, and a complete description of the problem. This information is needed in order to better respond to your request for assistance.



FSP is a registered trademark of Whirlpool Corporation for quality parts. Look for this symbol of quality whenever you need a replacement part for your Whirlpool appliance. FSP replacement parts will fit right and work right, because they are made to the same exacting specifications used to build every new Whirlpool appliance.



Making your world a little easier.

Part No. 1109124  
©1985 Whirlpool Corporation

Printed in U.S.A.

Ice Makers, Dishwashers, Built-In Ovens and Surface Units, Ranges, Microwave Ovens, Trash Compactors, Room Air Conditioners, Dehumidifiers, Automatic Washers, Clothes Dr

